

JBX1-07 - IP40 (7 x Ø 0.7mm)

Dimensions (For mated connector lengths see page 121)

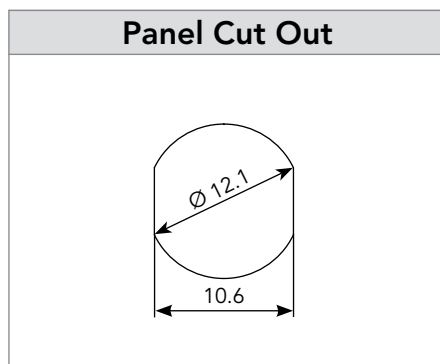
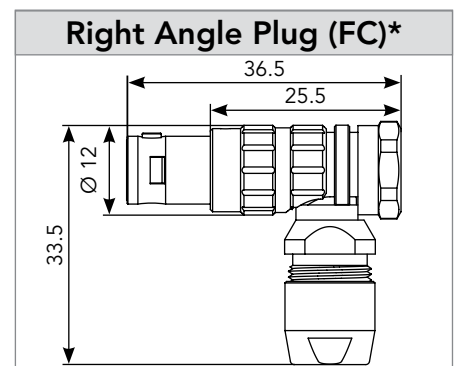
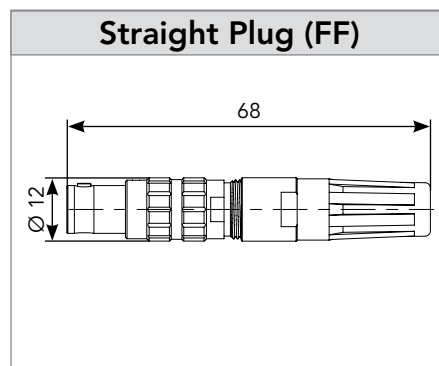
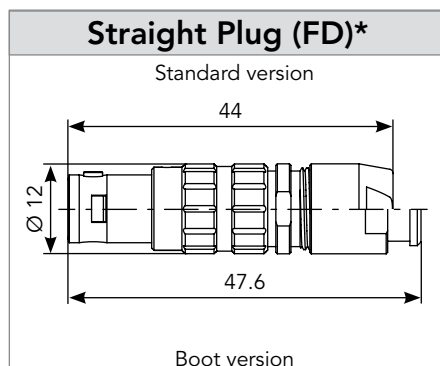
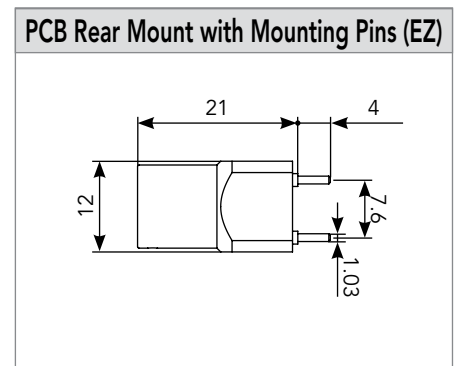
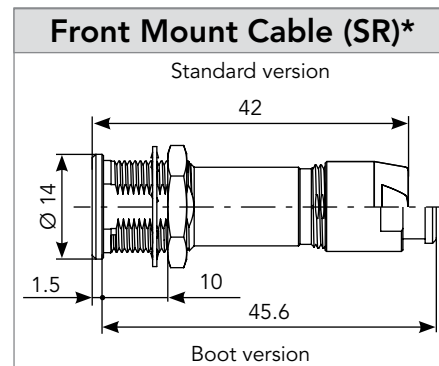
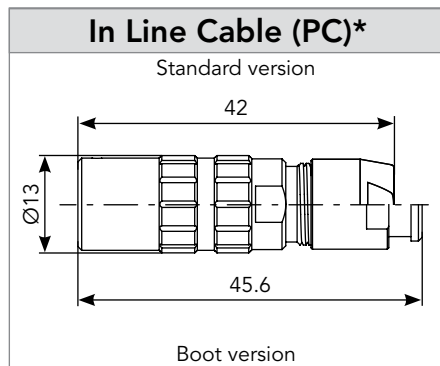
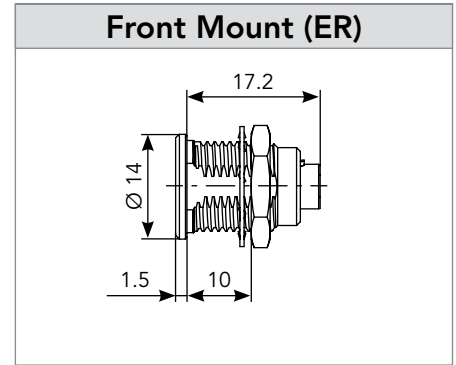
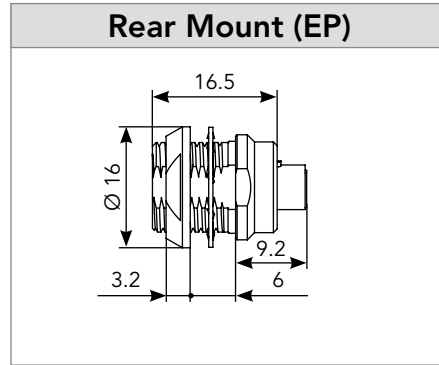
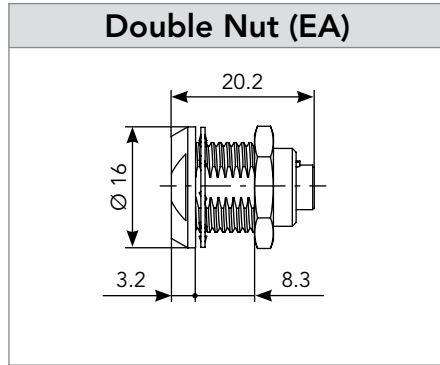

Note: all dimensions are in mm