



Slide Lock Environmental Connector

SLE Slide Lock Environmental connectors were designed to meet the most demanding requirements of under-the-hood applications. These connectors are very easy to assemble and maintain. Extremely user friendly, these connectors feature an audible and tactile feedback and can be unmated simply by depressing the slide locks and pulling back on the connector body. The contacts will handle up to five amps continuous at fully rated temperature range, -40°C to +125°C, and can handle wire size from 20 AWG to 16 AWG.

Applications

- Engine Electronics
- Instrumentation
- Automotive CPUs

Features

Rectangular Connector Bodies

SLE's rectangular design is ideally suited for easy printed circuit board layouts for both straight off-the-board and right angle applications, since the contacts are precisely arranged in rows.

Keyable Connector Bodies

Four simple slotted keys and keyways are supplied with the connectors that allow the user to key connector halves. This prevents connectors of the same shell size, mounted in close proximity to each other, from being mated with the incorrect connector and damaging the sophisticated electronic controls modules.

Clamshell Style Plug Cable Clamps for any Cable Orientation

Plug cable clamps are ordered as part of the connector and are available in five different styles; up, down, right, left and straight cable exits. This saves space and allows easy mating in the crowded under-the-hood environments. See How to Order page for more details.

Strong Connector Slide Locks

Slide locks are located at either end of the SLE connectors. These locks are molded right into the connector bodies and lock the connectors together when mated. To unmate just depress the slide locks simultaneously and pull the connectors apart.

Technical Specifications

MATERIALS & FINISHES

Shell	High performance thermoplastic body, silicone wire seals
Contacts	Copper alloy
Plating	Selective gold over nickel plating on mating surface, tin/lead over nickel plating on wire crimp area.

ELECTRICAL DATA

Dielectric Withstanding Voltage	1000 Vac rms at sea level
Current Rating	5 Amps continuous at 125°C
Wire Range Sizes	20-16 AWG
Contact Resistance	10 milliohms maximum
Insulation Resistance	20 megohms minimum (USCAR)

MECHANICAL

Operating Temperature	-40°C to 125°C (-40°F to 257°F)
Sealing	2-12 inches of 5% salt solution for 24 hours
Wire Sealing Range	.095"-.120" (2.42mm - 3.05mm)
Insulation Strip Length	.210" - .220" (5.33mm - 5.59mm)
Mating Life	25 cycles minimum
Salt Spray	5% solution 96 hours
Heat	125°C +/- 3° 1000 hours
Chemical Resistance	Resistant to most common automotive contaminants (see test data)
Vibration	10.2 grms 20 hours min.(see test data)
Shock	100 g's 18 shocks for 6 milliseconds
Contact Type	Crimp using automatic, semi-automatic or hand tooling, printed circuit
Number of Circuits	19 & 28
Contact Insertion	From rear with no insertion tool needed
Contact Removal	From rear with low cost hand tool
Contact Retention	25 lbs. (111N) minimum
Polarization	Moveable molded keys and keyways

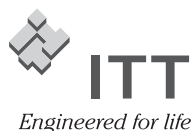

How to Order

SLEB19

S2

D

Step 1

Pick # of Contacts
SLEB19 or SLEC28
19 Contacts/28 Contacts

Step 2

Connector Style

Step 3

Cable Entry Style

Step 4

Mounting Hardware

SLEB19

P4 = Pin Crimp Receptacle
S2 = Socket Crimp Plug
T3 = PC Sockets Straight Plug
N3 = PC Socket Right Angle Plug
S = Straight Endbell
L = Left Endbell
R = Right Endbell
U = Up Endbell
D = Down Endbell
P = Potted PC Contacts
No Modification leave blank
F = Flange Mount (Plug only)
G = Screwlocks
M = Metric M3.5 x .60 Threaded
N = 6-32 UNC Threaded
E = 6-32 X .56 Spacer
Convert to Order #

19 CONTACTS

	P4	S2	T3	N3	S	L	R	U	D	P	No Modification leave blank	F	G	M	N	E	Convert to Order #
P4					S												130408-0000
P4					S						*		G				130408-0010
P4						L					*						130408-0001
P4							R				*						130408-0002
P4								U			*						130408-0003
P4								U				G					130408-0011
P4									D		*						130408-0004
P4									D			G					130408-0012
▲ MATES WITH ▼																	
	S2				S						*						130409-0001
	S2				S							F					130409-0000
	S2					L					*						130409-0002
	S2						R				*						130409-0003
	S2							U			*						130409-0004
	S2								D		*						130409-0005
		T3								P	*						130411-0000
		T3								P			M				130411-0001
		T3								P				N			130411-0002
		T3								P					E		130411-0015
			N3							P	*						130410-0000
			N3							P			M				130410-0001
			N3							P				N			130410-0002
			N3							P					E		130410-0015

For High Volume Low Temperature (100°C) Low Cost Tin Lead Contacts, Please Call.







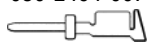
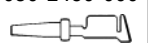

SLEC28

28 CONTACTS

	P4	S2	T3	N3	S	L	R	U	D	P	No Modification leave blank	F	G	M	N	E	Convert to Order #
P4					S						*						130412-0000
P4					S								G				130412-0010
P4						L					*						130412-0001
P4							R				*						130412-0002
P4								U			*						130412-0003
P4								U				G					130412-0011
P4									D		*						130412-0004
P4									D			G					130412-0012
▲ MATES WITH ▼																	
	S2				S						*						130413-0001
	S2				S							F					130413-0000
	S2					L					*						130413-0002
	S2						R				*						130413-0003
	S2							U			*						130413-0004
	S2								D		*						130413-0005
		T3								P	*						130415-0000
		T3								P			M				130415-0001
		T3								P				N			130415-0002
		T3								P					E		130415-0004
			N3							P	*						130414-0000
			N3							P			M				130414-0001
			N3							P				N			130414-0002
			N3							P					E		130414-0020

See pages 37-39 for Dimensions.

Dimensions

16-20 AWG	Pins For Receptacles	Sockets For Plugs	Crimp Tool	Strip Length	Wire Sealing Range	Wire Hole Filler	Extraction Tool
Loose	030-2464-007 	030-2480-000  030-2480-007 Hooded	112108-0007 	 .210 - .220 (5.33-5.99mm)	 .095 - .130 (2.42-3.30mm)	225-0093-000 	274-7068-001 
Reel of 4500 pcs.	110238-0446 	110238-0488  110238-1016 Hooded	Automatic/ Semi-Automatic Please Call				323-9519-000 Replacement Tip

S2 Plug

With Flange Endbell
(Plug Only)

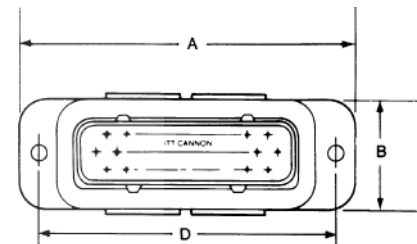
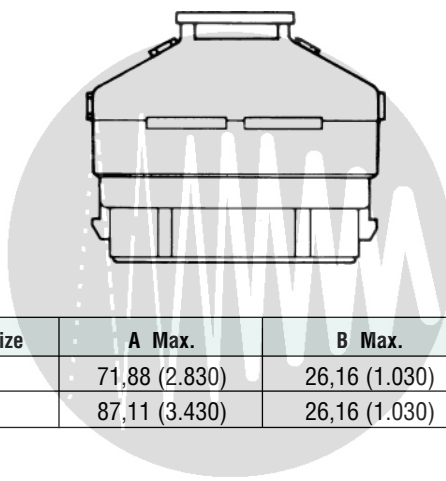
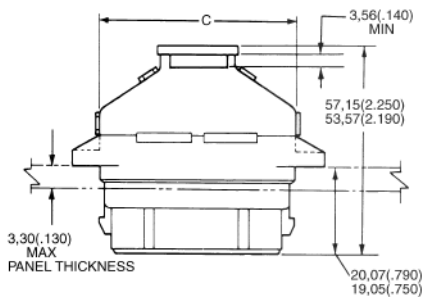

No. of Contacts	Part Number by Shell Size	A Max.	B Max.	C Max.	D ±0,38 (.015)
19	SLEB	71,88 (2.830)	26,16 (1.030)	47,50 (1.870)	59,05 (2.325)
28	SLEC	87,11 (3.430)	26,16 (1.030)	62,74 (2.470)	74,29 (2.925)

P4 Receptacle

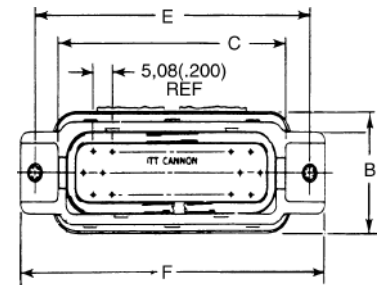
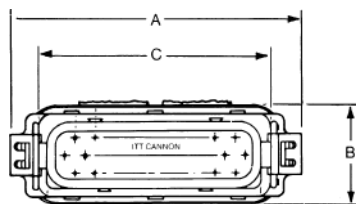
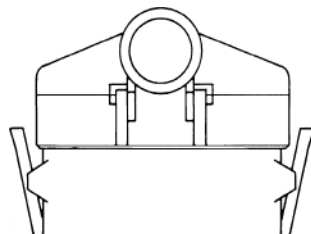
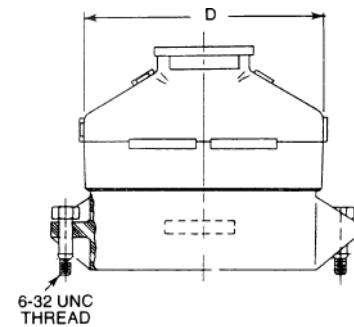
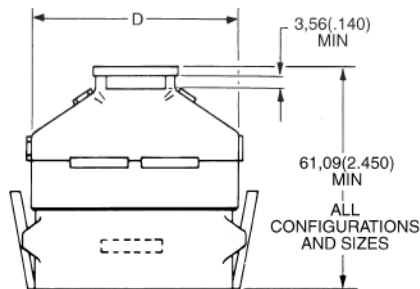
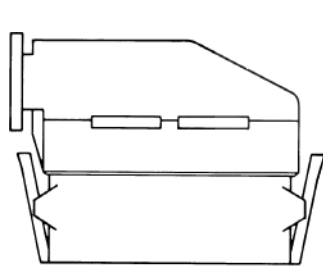

No. of Contacts	Part Number by Shell Size	A Max.	B Max.	C Max.	D Max.	E ±0,38 (.015)	F Max.
19	SLEB	59,44 (2.340)	26,16 (1.030)	44,07 (1.735)	50,58 (2.000)	55,87 (2.200)	64,25 (2.530)
28	SLEC	76,45 (3.010)	26,16 (1.030)	59,31 (2.335)	66,04 (2.600)	71,11 (2.800)	79,49 (3.130)

All dimensions are in mm(inches) unless otherwise indicated.

Dimensions

Printed Circuit Board Plug

T3 Straight

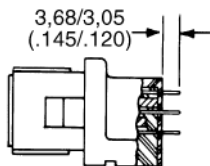

N3 Right Angle

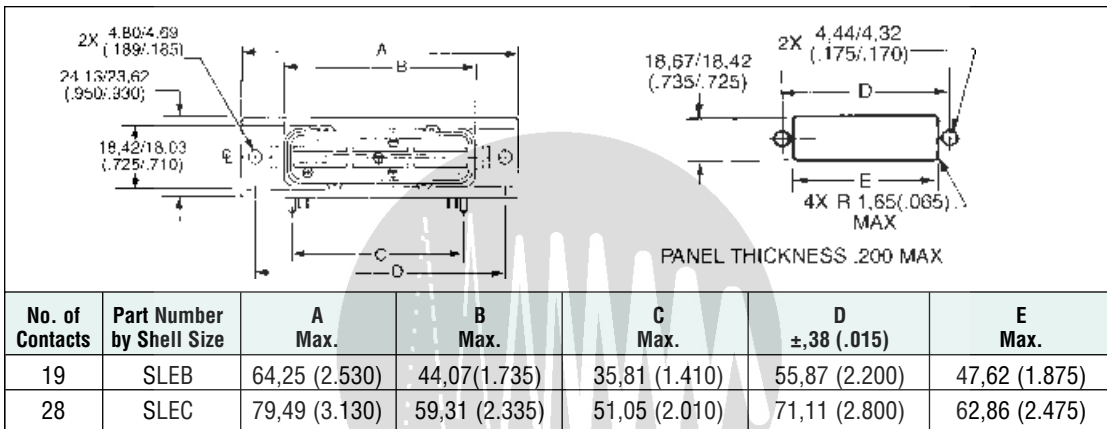
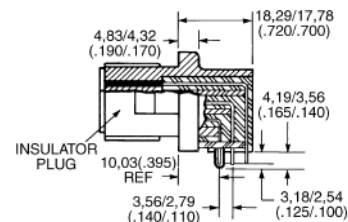

19 Contacts

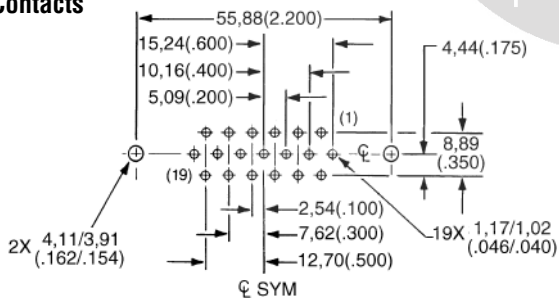

19 Contacts

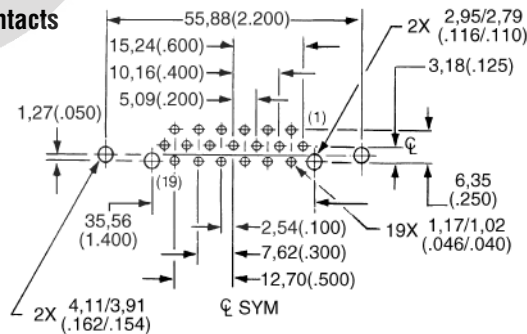

28 Contacts

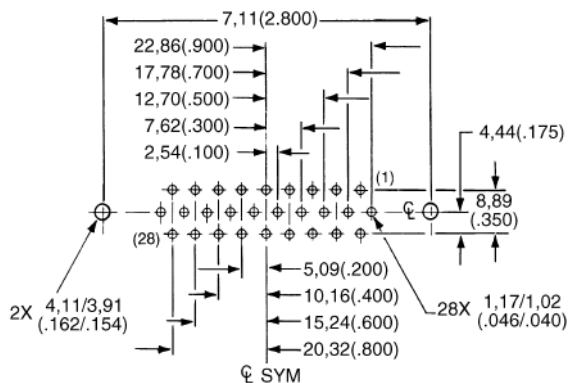

28 Contacts

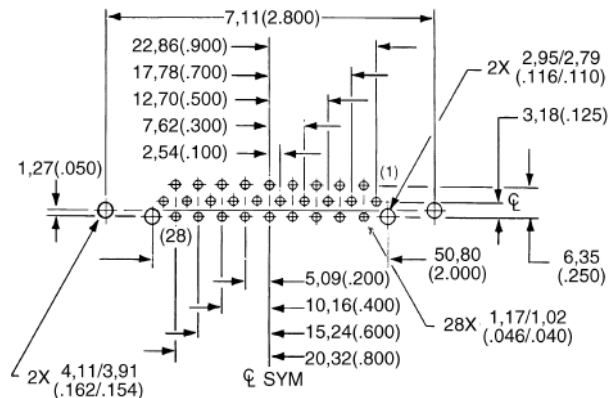

Dimensions

Contact Arrangement

Face View – Engaging Face of Plug

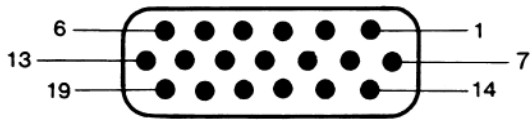

Size B
19 Contacts

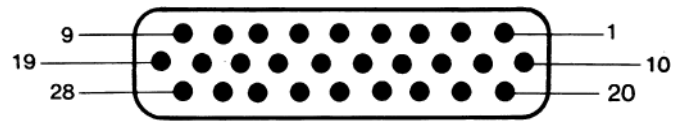

Size C
28 Contacts

Endbells

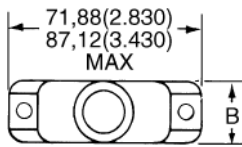

Flange Mount – (F)

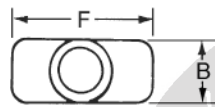

Straight – (S)

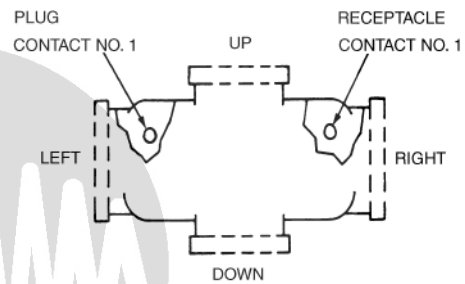

Other Endbell Views (From Rear)

“B” and “F” dimensions are the same for all SLE endbells

Part Number by Shell Size	B Max.	F Max.	Cable Entry I.D.
SLEB	26,16 (1.030)	50,80 (2.000)	14,73 (.580)
SLEC	26,16 (1.030)	66,04 (2.600)	19,81 (.780)

Polarization

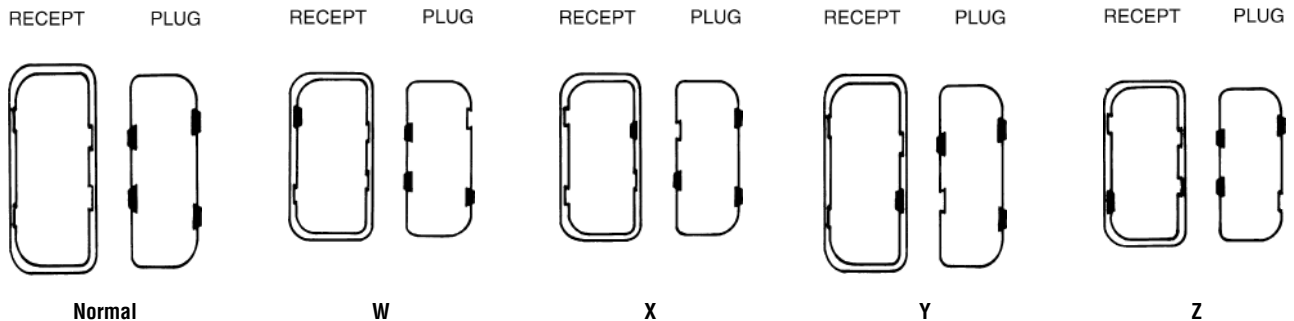







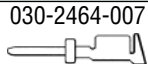
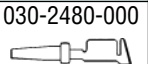

All dimensions are in mm(inches) unless otherwise indicated.

For price & delivery: 800-642-8750 • For tech support: 800-523-0727 • www.Peigenesis.com

Specifications subject to change.

Contacts & Tools

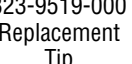
16-20 AWG	Pins	Sockets	Crimp Tool	Strip Length	Wire Sealing Range	Wire Hole Filler	Extraction Tool
Loose	030-2464-007 	030-2480-000  030-2480-007 Hooded	112108-0007 	 .210 - .220 (5.33-5.99mm)	 .095 - .130 (2.42-3.30mm)	225-0093-000 	274-7068-001 
Reel of 4500 pcs.	110238-0446 	110238-0488  110238-1016 Hooded	Automatic/ Semi-Automatic Please Call				323-9519-000 Replacement Tip 

Crimping

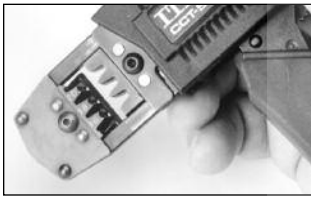

1. Cycle the CCT-SLE hand tool to the open position. Part No. 995-0002-232

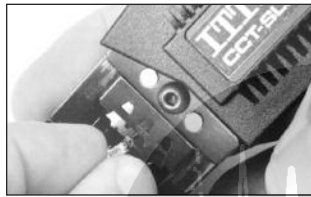

2. While pressing upward on the locator spring, insert the contact with tails upward completely into the locator.

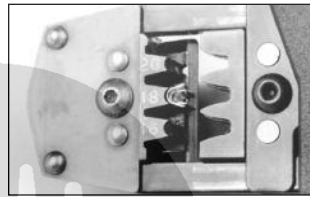

3. When correctly positioned the contact should be located beyond flush with the edge of the CCT-SLE and positioned on the concave polished split level crimp.

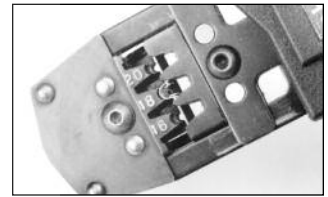

4. Partially cycle (usually the first click) the hand tool assuring that the upward thrusting tails of the contact has started engaging with the top jaw of the tool. (There is a slight tendency for the contact to roll out of vertical alignment.)

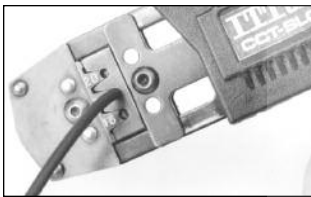

5. Insert the pre-stripped wire into the crimp area of the contact and completely cycle the tool.

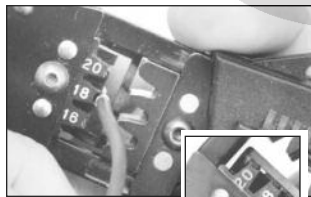

6. While pressing upward on the locator spring, withdraw the crimp termination. The result will be a perfect termination.



1. Note that there are no un-terminated wire strands, and that some strand ends can be seen at the forward edge of the crimp. Also note the insulation is gripped by the smaller secondary crimp. Distortion is at a minimum, both axially and laterally – no sharp edges. Enlargement of micro section allows for final judgement of crimp quality. This test is recommended whenever new tools or new types of wire are used.



1. Insert contact from rear; an audible snap can be felt and heard. Slight pull in the opposite direction will confirm complete insertion.

Extraction (SLE shown)



1. Open the CET-SLE extraction tool and place it over the insulation of the wire.



2. Using a straight motion forward, insert the tool along the wire until it bottoms against the connector. (Do not use a screwing motion, damage will result.)



3. While the CET-SLE is bottomed, simply pull the wire/contract assembly out.



4. Remove the CET-SLE. Extraction is complete.