

NEW S SERIES CONNECTOR



The S series available with new design

This product is a new design of the S series. It offers a new outershell design with LEMO's famous chocolate bar shape.

The product uses the S series half-moon inserts and is fully compatible with the existing S series sockets on the market. Both straight plug and free socket use the collet of the B series, offering a slightly different cable

range than the existing S series. Finally the product is available in 0S, 1S and 2S size connector for cables ranging from 1.4 mm to 9.9 mm and from 2 to 10 contacts.

The product is IP 50. For full insulator configuration availability please refer to LEMO's unipole-multipole connector range.

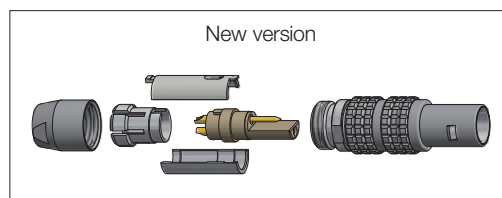
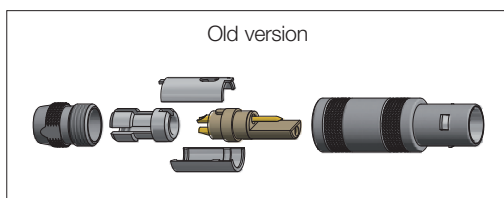

Part Numbering System

Plug and free socket

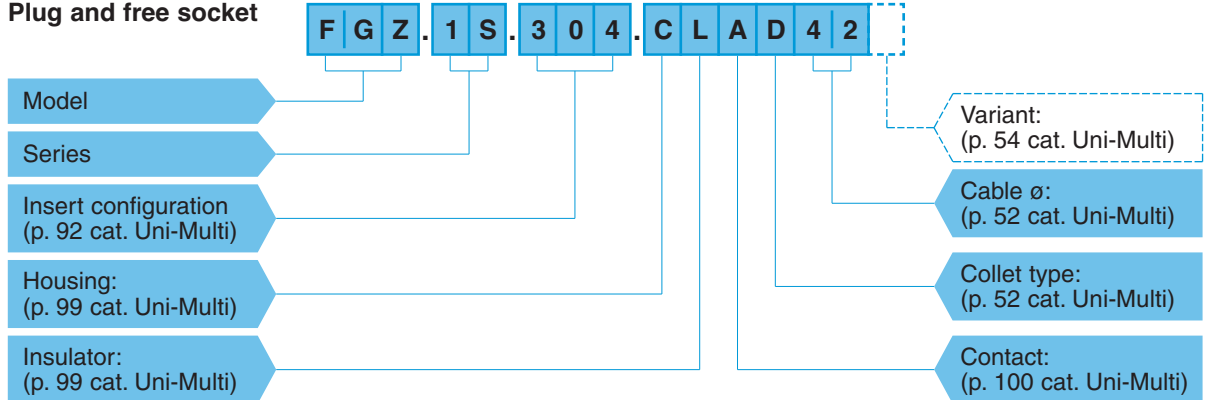

FGZ Straight plug, cable collet

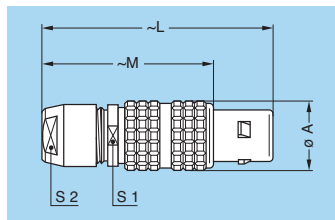
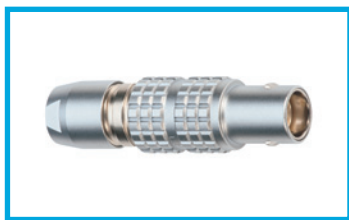

Reference		Dimensions (mm)				
Model	Series	A	L	M	S1	S2
FGZ	0S	9.5	36.0	26	8	7
FGZ	1S	12.0	43.0	32	10	9
FGZ	2S	15.0	50.0	38	13	12

FGZ Straight plug, cable collet and nut for fitting a bend relief

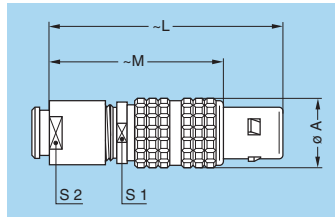
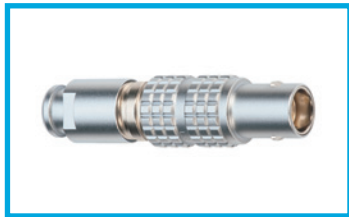

Reference		Dimensions (mm)				
Model	Series	A	L	M	S1	S2
FGZ	0S	9.5	35.0	25	8	7
FGZ	1S	12.0	42.0	31	10	9
FGZ	2S	15.0	49.0	37	13	12

PGZ Free socket, cable collet

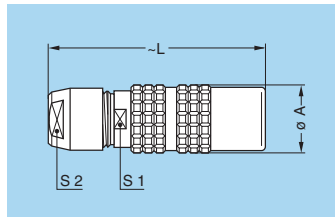
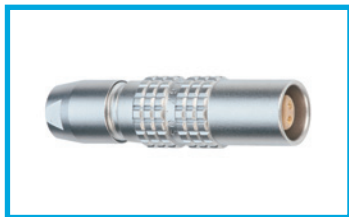

Reference		Dim. (mm)			
Model	Series	A	L	S1	S2
PGZ	0S	9.5	35.5	8	7
PGZ	1S	12.5	40.5	10	9
PGZ	2S	16.5	47.0	13	12

PGZ Free socket, cable collet and nut for fitting a bend relief

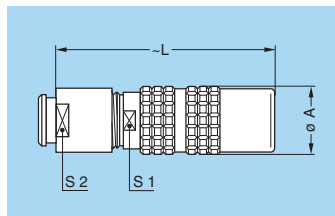
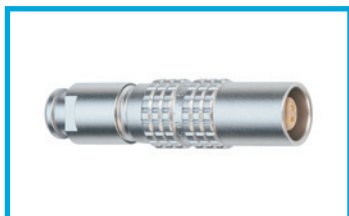

Reference		Dim. (mm)			
Model	Series	A	L	S1	S2
PGZ	0S	9.5	34.5	8	7
PGZ	1S	12.5	39.5	10	9
PGZ	2S	16.5	46.0	13	12

LEMO HEADQUARTERS

SWITZERLAND
LEMO SA
Chemin des Champs-Courbes 28 - P.O. Box 194 - CH-1024 Ecublens
Tel. (+41 21) 695 16 00 - Fax (+41 21) 695 16 02 - e-mail: info@lemo.com

www.lemo.com